



**REDONDO  
STANDARD**

Asiento Redondo  
Round Seat

REF 07000130.COLOR

# Ficha Técnica

## Cut Sheet

# REDONDO STANDARD

## Asiento Redondo / Round Seat











### Información técnica

Technical Information

Material Material	100% polipropileno 100% polypropylene
Dimensiones (An x L x AL) Dimensions (L x L x H)	406 x 364 x 39 mm. 406 x 364 x 39 mm.
Peso Weight	1.01 kg 1.01 kg
Incluye Items included	Tuercas y visagras Nuts and hinges

### Color

Color

 Blanco .020 White .020	 Bone .021 Bone .021
 Gris .165 Grey .165	 Negro .178 Black .178
 Azul .209 Blue .209	 Logan Berry .210 Logan Berry .210
 Day dream .225 Day dream .225	 Candle light .225 Candle light .225
 Mink .190 Mink .190	 Spring .227 Spring .227
 Verde Tropical .211 Green Tropical .211	

### Cuidados y limpieza

Attendance and cleanliness

Los acabados superficiales son aquellos que le imprimen una apariencia especial y estética a su producto y además le brindan protección.

Para prolongar sus cualidades es vital que la limpieza profunda del producto se haga únicamente con agua y jabón suave y que en el secado y el brillo se utilice un paño de algodón limpio; Por ningún motivo deben usarse elementos abrasivos, ácidos o disolventes para la limpieza del producto.

Surface finishes are those that give an appearance special and aesthetic to your product and also provide protection.

To prolong its qualities it is vital that the deep cleaning of the product is done only with water and mild soap and that in drying and shine it is used a clean cotton cloth; For no reason should they use abrasive elements, acids or solvents for cleaning the product.

### Plano técnico

Technical Drawing

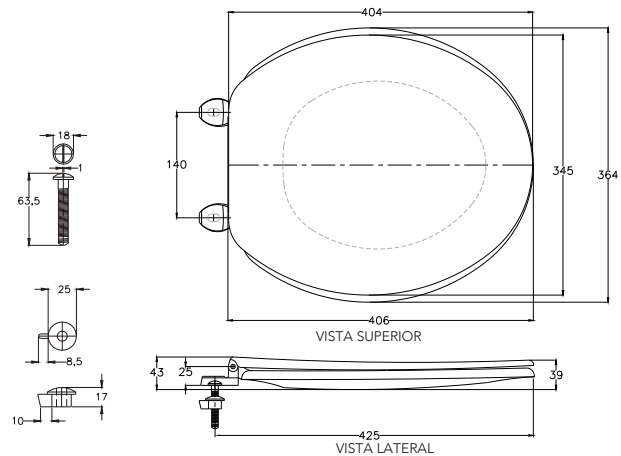

GARANTÍA DE 2 AÑOS PRODUCTO,  
LIMITED WARRANTY 2 YEARS IN PRODUCT.



SERVICIO POST VENTA  
AFTER SALE SERVICE

Panamá: (507) 800-0202  
Costa Rica: (506) 4001-4966  
Guatemala: (502) 1800-6240-109  
Honduras, San Pedro Sula: (504) 9482-6710  
Honduras, Tegucigalpa: (504) 9767-0821  
Nicaragua: (505) 2249-5521  
El Salvador: (503) 2274 4620  
postventa@incesastd.com

PISO TERMINADO / FINISHED FLOOR

Unidades / Units: mm.

Estas dimensiones son nominales y son sujetas a cambio sin previo aviso.  
These dimensions are nominal and are subject to change without prior notice.